QuantaMesh **Network Switch**

Installation Guide

Quanta[®]

SAFETY & REGULATORY INFORMATION

Copyright

All specifications and figures are subject to change without prior notice. Actual products may look different from the photos.

All trademarks and logos mentioned in this guide are the properties of their respective holders.

Copyright © 2015 Quanta Computer Inc. All rights reserved.

About the Manual

This installation guide is meant for network administrators with inept knowledge in network management.

To avoid personal injury or property damage, before you begin installing the product, read, observe, and adhere to all the following safety instructions and information.

The following symbols are used throughout the guide to highlight important information and may be marked on the product and / or the product packaging.



NOTE

Indicates useful information.



WARNING

Indicates safety information that if ignored may cause the system to malfunction or damage other equipment.



CAUTION

Indicates safety information that if ignored may cause personal injury or death.

Intended Application Uses

This product was evaluated as Information Technology Equipment (ITE), which may be installed in offices, schools, computer rooms, and similar commercial type locations. The suitability of this product for other product categories and environments (such as medical, industrial, residential, alarm systems, and test equipment), other than an ITE application, may require further evaluation.

Safety Information

Switch Safety Information

To reduce the risk of body injury, electrical shock, fire, and equipment damage, read this document and observe all warnings and precautions before installing or maintaining your switch.

In the event of a conflict between the information in this document and the information provided with the product or on the website of a particular product, the product documentation takes precedence.

The switch should be integrated and serviced only by technically qualified persons.

You must adhere to the guidelines in this guide and the assembly instructions in the switch manuals to ensure and maintain compliance with existing product certifications and approvals. Use only the described, regulated components specified in this guide. Use of other products / components will void the UL Listing and other regulatory approvals of the product, and may result in noncompliance with product regulations in the region(s) in which the product is sold.

Follow the safety guidelines below to ensure personal safety and protect the system and the working environment from potential damage.



CAUTION

- The power supplies in the system may produce high voltages and energy hazards which can cause bodily harm. Do not remove the covers and access any of the components inside the system.
- To reduce the risk of electrical shock, disconnect all power supply cables before servicing the system.
- Do not use the mounted equipment as a shelf or a work space.
- **Restricted Access Location:** The switch is intended for installation only in a Server Room or Computer Room where both these conditions apply:
 - ✓ access can only be gained by SERVICE PERSONS or by USERS who have been instructed about the reasons for the restrictions applied to the location and about any precautions that shall be taken; and
 - ✓ access is through the use of a TOOL or lock and key, or other means of security, and is controlled by the authority responsible for the location.



WARNING

When a power supply needs replacement, replace the power supply only with the same or equivalent type recommended by the manufacturer. Replacing with an incorrect power supply may cause explosion.

- Observe and follow service markings. Do not service the product yourself. Components inside the system should only be serviced by trained service technician.
- If any of the following conditions occur, unplug the equipment from the electrical outlet and replace the part or contact a trained service technician:
 - ✓ The power cable, extension cable, or plug is damaged
 - ✓ The equipment has been exposed to water
 - ✓ The equipment has been dropped or damaged
 - ✓ The equipment does not operate correctly when you follow the operating instructions
- Do not spill food or liquid on the equipment.
- Never operate the equipment in a wet environment.
- Do not push any objects into the opening of the equipment. Doing so may short internal components and cause fire or electric shock.
- Use the system only with approved equipment.
- Allow the product to cool before removing any peripherals.
- Operate the equipment only from the type of external power source indicated on the electrical ratings label. If you are unsure of the type of power source required, consult your local power company.
- Use only approved power cable(s).
- To help prevent electric shock, plug the system and peripheral power cables into properly grounded electrical outlets. Do not use adapter plugs or remove the grounding prong from a cable. If you must use an extension cable, use an extension cable with properly grounded plugs.
- Observe and follow service markings. Do not service the product yourself. Components inside the system should only be serviced by trained service technician.
- If any of the following conditions occur, unplug the equipment from the electrical outlet and replace the part or contact a trained service technician:
 - ✓ The power cable, extension cable, or plug is damaged
 - ✓ The equipment has been exposed to water
 - ✓ The equipment has been dropped or damaged
 - ✓ The equipment does not operate correctly when you follow the operating instructions
- Do not spill food or liquid on the equipment.
- Never operate the equipment in a wet environment.

SAFETY & REGULATORY INFORMATION

- Do not push any objects into the opening of the equipment. Doing so may short internal components and cause fire or electric shock.
- Use the system only with approved equipment.
- Allow the product to cool before removing any peripherals.
- Operate the equipment only from the type of external power source indicated on the electrical ratings label. If you are unsure of the type of power source required, consult your local power company.
- Use only approved power cable(s).
- To help prevent electric shock, plug the system and peripheral power cables into properly grounded electrical outlets. Do not use adapter plugs or remove the grounding prong from a cable. If you must use an extension cable, use an extension cable with properly grounded plugs.
- Observe extension cable and power strip ratings. Ensure that the total ampere rating of all products plugged into the extension cable or power strip does not exceed 80% of the ampere ratings limit for the extension cable or power strip.
- To protect the equipment from sudden, transient increase or decrease in electrical power, use a surge suppressor, line conditioner, or uninterruptible power supply (UPS).
- Do not modify power cables or plugs. Consult a licensed electrician or your power company for site modifications. Always follow your local/national wiring rules.
- To avoid possible damage to the system board, wait 5 seconds after turning off the system before removing a component from the system board or disconnecting a peripheral device.
- When connecting or disconnecting power to the hot-pluggable power supply units, observe the following guidelines:
 - ✓ Unplug the power cable before removing the power supply.
 - ✓ Install the power supply to the system before connecting the power cable to the power supply.
 - ✓ If the system has multiple sources of power, disconnect power from the system by unplugging all power cables from the power supplies.
- When disconnecting a cable, pull on its connector or on its strain-relief loop, and not on the cable itself.

Installation Assembly Safety Instructions

- The power supply in this product contains no user-serviceable parts. Refer servicing only to qualified personnel.
- Do not attempt to modify or use the supplied AC power cord if it is not the exact type required. A product with more than one power supply will have a separate AC power cord for each supply.
- To remove the AC power from the system, you must unplug each AC power cord from the wall outlet or power supply. The power cord(s) is considered the disconnect device to the main (AC) power. The socket outlet that the system plugs into shall be installed near the equipment and shall be easily accessible.
- A microprocessor and heat sink may be hot if the system has been running. Also, there may be sharp pins and edges on some board and chassis parts. Contact should be made with care. Consider wearing protective gloves.
- Danger of explosion if the battery is incorrectly replaced. Replace only with the same or equivalent type recommended by the equipment manufacturer. Dispose of used batteries according to manufacturer's instructions.
- The system is safety certified as rack-mounted equipment for use in a server room or computer room, using the customer rack kit. The rail racks are designed to carry only the weight of the system. Do not place additional load onto any rail-mounted equipment. System rack kits are intended to be installed in a rack by trained service technicians.

Site Selection

The system is designed to operate in a typical office environment. Choose a site that is:

- Clean and free of airborne particles (other than normal room dust).
- Well ventilated and away from sources of heat including direct sunlight and radiators.
- Away from sources of vibration or physical shock.
- Isolated from strong electromagnetic fields produced by electrical devices.
- In regions that are susceptible to electrical storms, we recommend you plug your system into a surge suppressor and disconnect telecommunication lines to your modem during an electrical storm.
- Provided with a properly grounded wall outlet.
- Provided with sufficient space to access the power supply cord(s), because they serve as the product's main power disconnect.
- Provided with either two independent AC power sources or two independent phases from a single source.

Equipment Handling Practices

Reduce the risk of personal injury or equipment damage:

- Conform to local occupational health and safety requirements when moving and lifting equipment.
- Use mechanical assistance or other suitable assistance when moving and lifting the equipment.
- To reduce the weight for easier handling, remove any easily detachable components.

Power and Electrical Warnings



CAUTION

- The power is active whenever the system is plugged in. To remove power from the system, you must unplug the AC power cord from the wall outlet. Your system may use more than one AC power cord. Make sure all AC power cords are unplugged. Make sure the AC power cord(s) is/are unplugged before you open the chassis, or add or remove any non hot-plug components.
- Do not attempt to modify or use an AC power cord if it is not the exact type required. A separate AC cord is required for each system power supply.
- The power supply in this product contains no user-serviceable parts. Do not open the power supply. Hazardous voltage, current and energy levels are present inside the power supply. Return to manufacturer for servicing.
- When replacing a hot-plug power supply, unplug the power cord to the power supply being replaced before removing it from the switch.

Power Cord Warnings

If an AC power cord was not provided with your product, purchase one that is approved for use in your country.



CAUTION

- To avoid electrical shock or fire, check the power cord(s) that will be used with the product as follows:
 - ✓ access can only be gained by SERVICE PERSONS or by USERS who have been instructed about the reasons for the restrictions applied to the location and about any precautions that shall be taken; and
 - ✓ access is through the use of a TOOL or lock and key, or other means of security, and is controlled by the authority responsible for the location.
- The power cord must have safety ground pin or contact that is suitable for the electrical outlet.
- The power supply cord(s) is/are the main disconnect device to AC power. The socket outlet(s) must be near the equipment and readily accessible for disconnection.
- The power supply cord(s) must be plugged into socket outlet(s) that is/are provided with a suitable earth ground.

System Access Warnings



CAUTION

- To avoid personal injury or property damage, the following safety instructions apply whenever accessing the inside of the product:
 - ✓ Turn off all peripheral devices connected to this product.
 - ✓ Disconnect the AC power by unplugging all AC power cords from the system or wall outlet.
 - ✓ Disconnect all cables and telecommunication lines that are connected to the system.
 - ✓ Retain all screws or other fasteners when removing access cover(s). Upon completion of accessing inside the product, refasten access cover with original screws or fasteners.
 - ✓ Do not access the inside of the power supply. There are no serviceable parts in the power supply. Return to the manufacturer for servicing.
 - ✓ Power down the switch and disconnect all power cords before adding or replacing any non hot-plug component.
 - ✓ When replacing a hot-plug power supply, unplug the power cord to the power supply being replaced before removing the power supply from the switch.
- Unless you are adding or removing a hot-plug component, allow the system to cool before opening the covers. To avoid the possibility of coming into contact with hot component(s) during a hot-plug installation, be careful when removing or installing the hot-plug component(s).
- To avoid injury do not contact moving fan blades. If your system is supplied with a guard over the fan, do not operate the system without the fan guard in place.

Rack Mount Warnings

The following installation guidelines are required by UL for maintaining safety compliance when installing your into a rack.

- The equipment rack must be anchored to an unmovable support to prevent it from tipping when a server or piece of equipment is extended from it. The equipment rack must be installed according to the rack manufacturer's instructions.
- Install equipment in the rack from the bottom up, with the heaviest equipment at the bottom of the rack.
- Extend only one piece of equipment from the rack at a time.
- You are responsible for installing a main power disconnect for the entire rack unit. This main disconnect must be readily accessible, and it must be labeled as controlling power to the entire unit, not just to the server(s).
- To avoid risk of potential electric shock, a proper safety ground must be implemented for the rack and each piece of equipment installed in it.
- Elevated Operating Ambient - If installed in a closed or multi-unit rack assembly, the operating ambient temperature of the rack environment may be greater than the room ambient. Therefore, consideration should be given to installing the equipment in an environment compatible with the maximum ambient temperature (T_{ma}) specified by the manufacturer.
- Reduced Air Flow - Installation of the equipment in a rack should be such that the amount of air flow required for safe operation of the equipment is not compromised.
- Mechanical Loading - Mounting of the equipment in the rack should be such that a hazardous condition is not achieved due to uneven mechanical loading.
- Circuit Overloading - Consideration should be given to the connection of the equipment to the supply circuit and the effect that overloading of the circuits might have on overcurrent protection and supply wiring. Appropriate consideration of equipment nameplate ratings should be used when addressing this concern.
- Reliable Earthing - Reliable earthing of rack-mounted equipment should be maintained.
- Particular attention should be given to supply connections other than direct connections to the branch circuit (e.g. use of power strips).

Other Hazards

Battery Replacement



CAUTION

- There is the danger of explosion if the battery is incorrectly replaced. When replacing the battery, use only the battery recommended by the equipment manufacturer.
- Dispose of batteries according to local ordinances and regulations.
- Do not attempt to recharge a battery.
- Do not attempt to disassemble, puncture, or otherwise damage a battery.

Cooling and Airflow



CAUTION

- Carefully route cables as directed to minimize airflow blockage and cooling problems. For proper cooling and airflow, operate the system only with the chassis covers installed. Operating the system without the covers in place can damage system parts. To install the covers:
 - ✓ Check first to make sure you have not left loose tools or parts inside the system.
 - ✓ Check that cables, add-in cards, and other components are properly installed.
 - ✓ Attach the covers to the chassis according to the product instructions.

Laser Peripherals or Devices



CAUTION

- To avoid risk of radiation exposure and/or personal injury:
 - ✓ Do not open the enclosure of any laser peripheral or device.
 - ✓ Laser peripherals or devices are not serviceable.
 - ✓ Return to the manufacturer for servicing.
 - ✓ Use certified Optical Fiber Transceiver Class 1 Laser Product.

Regulatory and Compliance Information

Electromagnetic Compatibility Notices

FCC Verification Statement (USA)1.5.1.1

This device complies with Part 15 of the FCC Rules. Operation is subject to the following two conditions: (1) this device may not cause harmful interference, and (2) this device may accept any interference received, including interference that may cause undesired operation.

This equipment has been tested and found to comply with the limits for a Class A digital device, pursuant to part 15 of the FCC Rules. These limits are designed to provide reasonable protection against harmful interference when the equipment is operated in a commercial environment.

This equipment generates, uses, and can radiate radio frequency energy and, if not installed and used in accordance with the instruction manual, may cause harmful interference to radio communications. However, there is no guarantee that interference will not occur in a particular installation. If this equipment does cause harmful interference to radio or television reception, which can be determined by turning the equipment off and on, the user is encouraged to try to correct the interference by one or more of the following measures:

- Reorient or relocate the receiving antenna.
- Increase the separation between the equipment and the receiver.
- Connect the equipment to an outlet on a circuit other than the one to which the receiver is connected.
- Consult the dealer or an experienced radio/TV technician for help.

Any changes or modifications not expressly approved by the grantee of this device could void the user's authority to operate the equipment. The customer is responsible for ensuring the compliance of the modified product.

Only peripherals (computer input/output devices, terminals, printers, etc.) that comply with FCC Class A or B limits may be attached to this computer product. Operation with noncompliant peripherals is likely to result in interference to radio and TV reception.

All cables used to connect to peripherals must be shielded and grounded. Operation with cables, connected to peripherals, that are not shielded and grounded may result in interference to radio and TV reception.

Europe (CE Declaration of Conformity)1.5.1.2

This product has been tested in accordance to, and complies with the Low Voltage Directive (73/23/EEC) and EMC Directive (89/336/EEC). The product has been marked with the CE Mark to illustrate its compliance.

VCCI (Japan)

この装置は、情報処理装置等電波障害自主規制協議会 (VCCI) の基準に基づくクラス A 情報技術装置です。この装置を家庭環境で使用すると電波妨害を引き起こすことがあります。この場合には使用者が適切な対策を講ずるよう要求されることがあります。

English translation of the notice above:

This is a Class A product based on the standard of the Voluntary Control Council for Interference (VCCI) from Information Technology Equipment. If this is used near a radio or television receiver in a domestic environment, it may cause radio interference. Install and use the equipment according to the instruction manual.

CCC Statement

声明

此为 A 级产品，在生活环境中，该产品可能会造成无线电干扰
在这种情况下，可能需要用户对其干扰采取切实可行的措施

Regulated Specified Components

To maintain the UL listing and compliance to other regulatory certifications and/or declarations, the following regulated components must be used and conditions adhered to. Interchanging or use of other component will void the UL listing and other product certifications and approvals.

Updated product information for configurations can be found on the site at the following URL:
<http://www.QuantaQCT.com>

If you do not have access to the Web address, please contact your local representative.

- Add-in cards: must have a printed wiring board flammability rating of minimum UL94V-1.
- Add-in cards containing external power connectors and/or lithium batteries must be UL recognized or UL listed. Any add-in card containing modem telecommunication circuitry must be UL listed. In addition, the modem must have the appropriate telecommunications, safety, and EMC approvals for the region in which it is sold.
- Peripheral Storage Devices: must be UL recognized or UL listed accessory and TUV and VDE licensed. Maximum power rating of any one device is 19 watts. Total server configuration is not to exceed the maximum loading conditions of the power supply.

Restriction of Hazardous Substances (RoHS) Compliance

Quanta® Computer Inc. has a system in place to restrict the use of banned substances in accordance with the European Directive 2002/95/EC. Compliance is based on declaration that materials banned in the RoHS Directive are either (1) below all applicable threshold limits or (2) an approved / pending RoHS exemption applies.

RoHS implementation details are not fully defined and may change.

Threshold limits and banned substances are noted below:

- Quantity limit of 0.1% by mass (1000 PPM) for:
 - √ Lead
 - √ Mercury
 - √ Hexavalent Chromium
 - √ Polybrominated Biphenyls Diphenyl Ethers (PBDE)
- Quantity limit of 0.01% by mass (100 PPM) for:
 - √ Cadmium

End of Life / Product Recycling

Product recycling and end-of-life take-back systems and requirements vary by country. Contact the retailer or distributor of this product for information about product recycling and/or take-back.

Product Regulatory Compliance Markings

This product is marked with the following product certification markings:





Regulatory Compliance	Region	Marking
cULus Listing Marks	USA / Canada	
CE Mark	Europe	
FCC Marking (Class A)	USA	This device complies with Part 15 of the FCC Rules. Operation of this device is subject to the following two conditions: (1) This device may not cause harmful interference, and (2) This device must accept any interference received, including interference that may cause undesired operation.
VCCI Marking (Class A)	Japan	この装置は、情報処理装置等電波障害自主規制協議会 (VCCI) の基準に基づくクラス A 情報技術装置です。この装置を家庭環境で使用すると電波妨害を引き起こすことがあります。この場合には使用者が適切な対策を講ずるようにより要求されることがあります。
ICES	Canada	This Class A digital apparatus complies with Canadian ICES-003. Cet appareil numérique de la classe A est conforme à la norme NMB-003 du Canada.
Recycling Package Mark	Other than China	 
CCC	China	 <div style="border: 1px solid black; padding: 5px; display: inline-block;"> <p style="text-align: center;">警告</p> <p>此为A级产品，在生活环境中，该产品可能会造成无线电干扰。在这种情况下，可能需要用户对干扰采取切实可行的措施。</p> </div>

TABLE OF CONTENTS

SAFETY & REGULATORY INFORMATION	2
PRODUCT OVERVIEW	13
Chassis for the T3048-LY8 Switch	13
Ports of T3048-LY8.....	14
Data Port Connection.....	14
Fan Tray of T3048-LY8.....	16
Power Supply of T3048-LY8.....	17
Airflow Direction	18
Chassis for the T5032-LY6 Switch	19
Ports of T5032-LY6.....	20
Data Port Connection.....	20
Fan Tray of T5032-LY6.....	21
Power Supply of T5032-LY6.....	22
Chassis for the T3048-LY9 Switch	24
Ports of T3048-LY9.....	25
Data Port Connection.....	25
Fan Tray of T3048-LY9.....	27
Power Supply of T3048-LY9.....	27
Airflow Direction	28
LED Descriptions	29
Chassis Indicators.....	29
Port Indicators.....	29
HARDWARE INSTALLATION	30
Unpacking the Hardware	30
Package Contents	30
Installing the Switch	30
Site Survey	30
Positioning the Switch.....	31
Rack Mounting the Switch	31
Connecting to the Console Port	33
Connecting to the Management Port	34
Connecting the Power	35
AC Power Supply.....	35
COMPONENTS REPLACEMENT	36
Troubleshooting	36
Diagnostic Switch Indicator	36
Power and Cooling Problems.....	36
Installation	36
In-Band Access	36
Replacing the Power Supply	37
Replacing the Fan Tray	39
Customer Support	39

APPENDIX	40
Initial Configuration Process	40
Configure the IP Address	40
Set IP Address Manually.....	40
Obtain IP Address by DHCP	41
Manage the Switch	42
CLI Management.....	42
SNMP Management.....	42
Upgrade the Firmware	43
Upgrade the Firmware Image File	43
Upgrade Kernel and Rootfs	45
Manually Install Vendor OS	47

PRODUCT OVERVIEW

Congratulations on your purchase of this QuantaMesh Network Switches. Built for Infrastructure-as-a-service (IaaS) datacenter deployment, high performance computing clusters, and financial applications, the very high port density and high performance as well as ultra-low latency characteristic makes this network switch ideal for demanding workloads and provides the best TCO.

Chassis for the T3048-LY8 Switch

Front panel

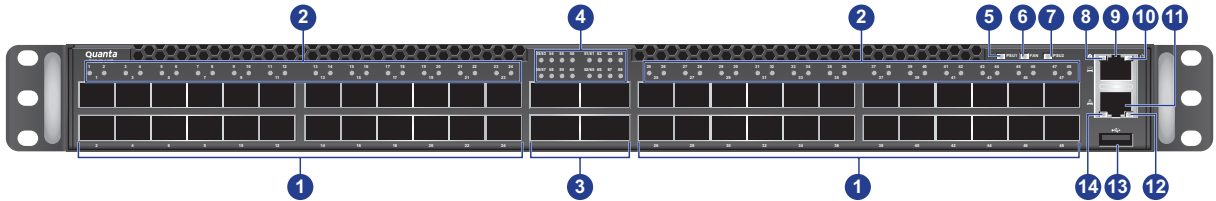

No.	Item
1	SFP+ Ports
2	SFP+ Port LEDs
3	QSFP+ Ports
4	QSFP+ Port LEDs
5	PSU1 LED
6	Fan LED
7	PSU2 LED

No.	Item
8	System info. LED
9	Console Port
10	Power LED
11	Management Port
12	Link/Activity LED
13	USB Port
14	Speed LED

Rear panel

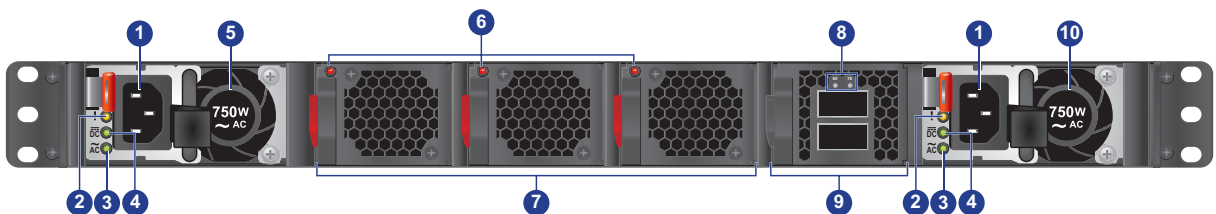

No.	Item
1	AC Power Connector (with Plug Retainer)
2	PSU Warning LED
3	PSU AC LED
4	PSU DC LED
5	PSU2

No.	Item
6	Fan LEDs
7	Hot-swappable Fan
8	QSFP+ Port LEDs
9	QSFP+ Ports
10	PSU1

Ports of T3048-LY8

The switch chassis is equipped with the following ports:

- 48 SFP+ ports (10-Gigabit Ethernet downlink ports)
- 6 QSFP+ ports (40-Gigabit Ethernet uplink ports)
- 1 Management ports
- 1 Console port
- 1 USB port

The chassis has 48 SFP+ and 6 QSFP+ ports. Each of these ports uses an optical transceiver, active optical cables, or direct-attached cable to connect the SFP+/QSFP+ port to the servers (downlink connections) or hosts (uplink connections). For more information on obtaining the appropriate SFP/QSFP+ modules, refer to [“Supported Cables and Transceivers” on page 14](#).

One management port enables you to manage the switch operation using an RJ-45 Ethernet cable.

One console port enables you to perform the initial configuration by connecting to a PC with the RJ-45 to DB-9 serial adapter cable.

*One USB port enables you to load the configuration files from a USB storage device to the switch’s flash memory.



NOTE:

- *The USB port function will be supported in the future release.

Data Port Connection

Supported Cables and Transceivers

See the following table for the list of supported cables and transceivers.

- **10-Gigabit ports**

Supported Distance	Description	Note
0.5m	10G SFP+ Direct Attach Copper (DAC) cable	
1m	10G SFP+ Direct Attach Copper (DAC) cable	850 nm, MMF
	10G QSFP+ Active Optical Cable (AOC)	
1.5m	10G SFP+ Direct Attach Copper (DAC) cable	
2m	10G SFP+ Direct Attach Copper (DAC) cable	
2.5m	10G SFP+ Direct Attach Copper (DAC) cable	
3m	10G SFP+ Direct Attach Copper (DAC) cable	850 nm, MMF
	10G SFP+ Active Optical Cable (AOC)	
5m	10G SFP+ Direct Attach Copper (DAC)	
7m	10G SFP+ Active Optical Cable (AOC)	850 nm, MMF
10m	10G SFP+ Active Optical Cable (AOC)	850 nm, MMF
20m	10G SFP+ Active Optical Cable (AOC)	850 nm, MMF
100m	10G SFP+ Active Optical Cable (AOC)	850 nm, MMF
>100m	10GBASE-SR SFP+ Transceiver Optic	850 nm, MMF
Up to 10km	10GBASE-LR SFP+ Transceiver Optic	1310 nm, SMF

• **40-Gigabit ports**

Supported Distance	Description	Note
1m	40G Direct Attach Copper (DAC) cable	QSFP+ to QSFP+
	40G DAC Fan Out cable	QSFP+ to 4 SFP+
3m	40G Direct Attach Copper (DAC) cable	QSFP+ to QSFP+
	40G DAC Fan Out cable	QSFP+ to 4 SFP+
5m	40G Direct Attach Copper (DAC) cable	QSFP+ to QSFP+
	40G DAC Fan Out cable	QSFP+ to 4 SFP+
7m	40G Active Optical Cable (AOC)	QSFP+ to QSFP+, 850 nm, MMF
10m	40G Active Optical Cable (AOC)	QSFP+ to QSFP+, 850 nm, MMF
20m	40G Active Optical Cable (AOC)	QSFP+ to QSFP+, 850 nm, MMF
> 20m	40GBASE-SR4 QSFP+ Transceiver Optic (MPO)	QSFP+, 850nm, MMF
Up to 10km	40GBASE-LR4 QSFP+ Transceiver Optic (LC)	QSFP+, SMF

 **NOTE:**

- For more information about the cable/transceiver, please contact QCT sales.

SFP+ Port Connection (LC Type Connector)

The switch is equipped with 48 SFP+ ports. The Small Form-Factor Pluggable Plus (SFP+) port is the second generation of the SFP interconnect system designed for 10Gb/s data rate. The SFP+ ports support 10-gigabit IEEE 802.3ae Ethernet for fiber mediums.

The SFP+ ports are numbered and have corresponding SFP+ port LEDs.

To install an SFP+ module, do the following:

- 1 Slide the SFP+ module into an SFP+ port.

 **NOTE:**

- Ensure the SFP+ module is positioned correctly before installing it into the port.

- 2 Push completely until the module locks into place.

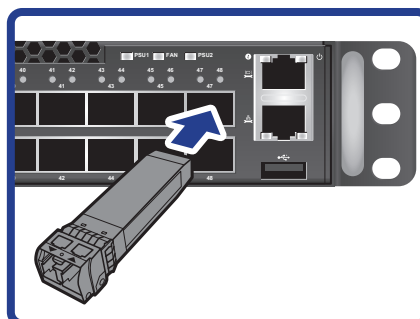

- 3 Repeat the above procedures to install additional SFP+ modules.

The SFP+ port LED lights green when the network link is established.

QSFP+ Port Connection (MPO Type Connector)

The switch is equipped with 6 QSFP+ (Quad SFP) ports. There are two types of QSFP+ ports:

- There are four 40G QSFP+ ports on the front panel which support 40G/per port or fan out to 4x10G by using the fan out DAC cable described in the “40-Gigabit ports” section on [page 15](#).
- The QSFP+ port on the rear panel provides only one channel of data in one pluggable interface.

The QSFP+ ports are numbered and have corresponding QSFP+ port LEDs.

To install a QSFP+ module, do the following:

- 1 Slide the QSFP+ module into a QSFP+ port.
- 2 Push completely until the module locks into place.

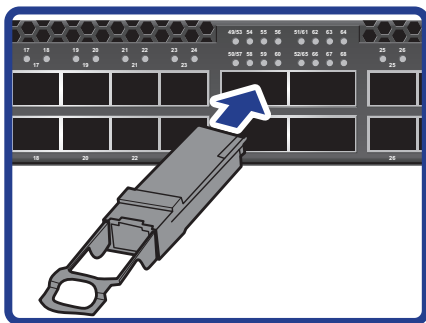

Front panel

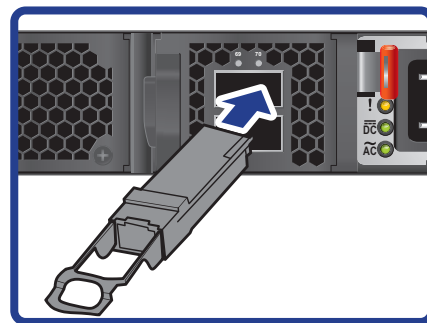

Rear panel

- 3 Repeat the above procedures to install additional QSFP+ modules.

The QSFP+ port LED lights green when the network link is established.

Fan Tray of T3048-LY8

The switch chassis is equipped with three fan trays. There are two types of hot-swappable fan modules. Each fan module handle is color-coded to indicate its airflow direction.

- Red: indicates front-to-back airflow.

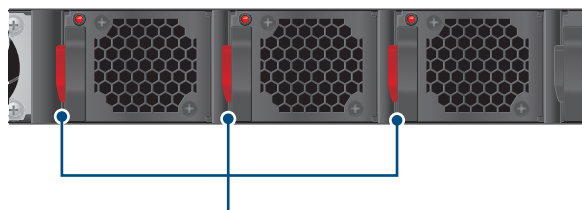

Fan module handles

- Blue: indicates back-to-front airflow.

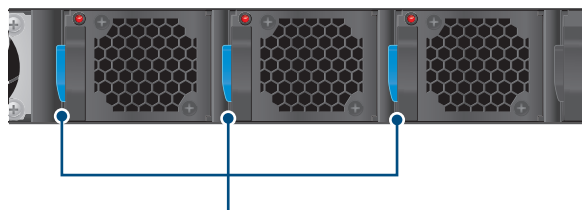

Fan module handles



NOTE:

- To hot-swap the fan during operations, make sure to replace it within two minutes.

Power Supply of T3048-LY8

Equipped with two supply modules, the switch can operate with either one or two power supply modules. If the switch uses two power supply modules, you can hot-swap one of the PSU during the operations.



NOTE:

- Only one PSU is required to operate a fully loaded chassis.

There are two types of PSU. Each plug retainer is color-coded to indicate its airflow direction.

- Red: indicates front-to-back airflow.
- Blue: indicates back-to-front airflow.

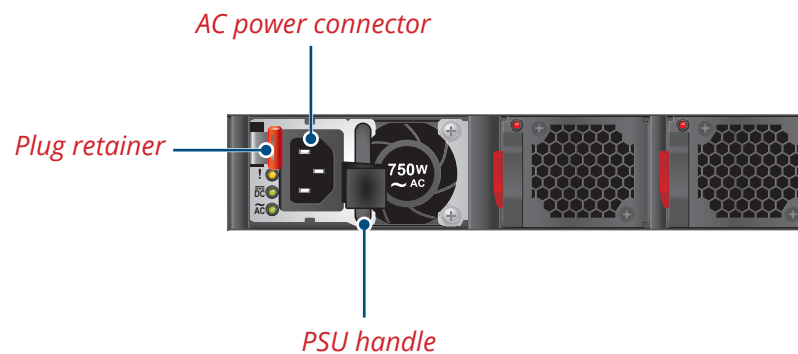

The AC power connector is a standard three-pronged connector. The switch automatically adjusts its power setting to any supply voltage in the range from 100~240 VAC at 50~60 Hz.



NOTE:

- Verify that each module has the same airflow direction. Make sure the switch runs with all of its power supply and fan tray modules taking in air from a cold aisle and exhausting air to the hot aisle.

Understanding the PSU LED

LED Type	LED Color	Function
Warning	Amber	PSU power / Thermal / Fan is not functioning properly.
AC	Green	The AC power (AC IN 220 / 110V) is operating normally.
	Off	The AC power (AC IN 220 / 110V) has failed.
DC	Green	The DC power (DC OUT +12V) is operating normally.
	Off	The DC power (DC OUT +12V) has failed.

Airflow Direction

The switch ships with three fan modules and two AC power supplies. The direction of the airflow varies depending on the color of the fan module handle/plug retainer.

- Red: indicates front-to-back airflow (air inlet module).
- Blue: indicates back-to-front airflow (air outlet module).



CAUTION

- Do not mix power supplies and fan modules with different airflow in the same chassis.

Front-to-Back Airflow

The air intake is located on the front panel of the switch. The cool air is sucked in from outside the chassis and pushed toward the rear of the chassis. The hot air exhausts through the vents on the rear panel of the switch.

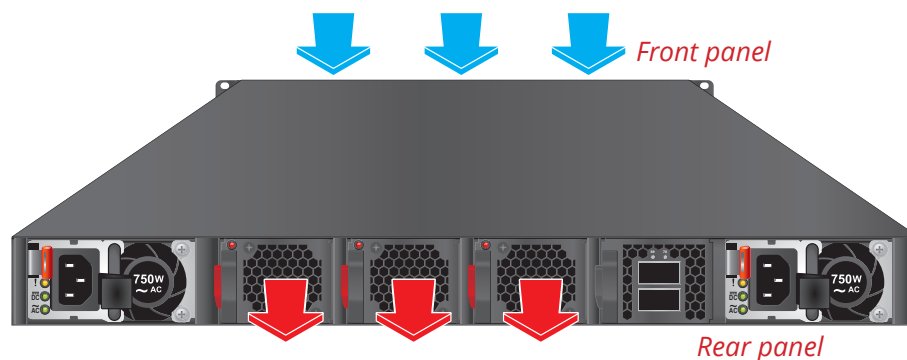

Back-to-Front Airflow

The air intake is located on the rear panel of the switch. The cool air is sucked in from outside the chassis and pushed toward the front of the chassis. The hot air exhausts through the vents on the front panel of the switch.

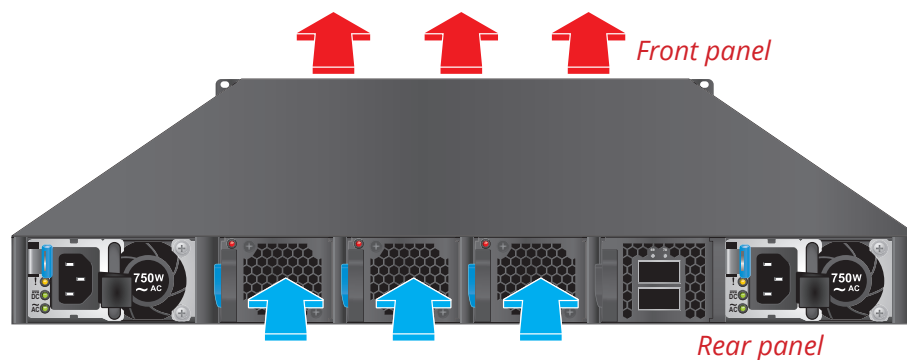

Chassis for the T5032-LY6 Switch

Front panel

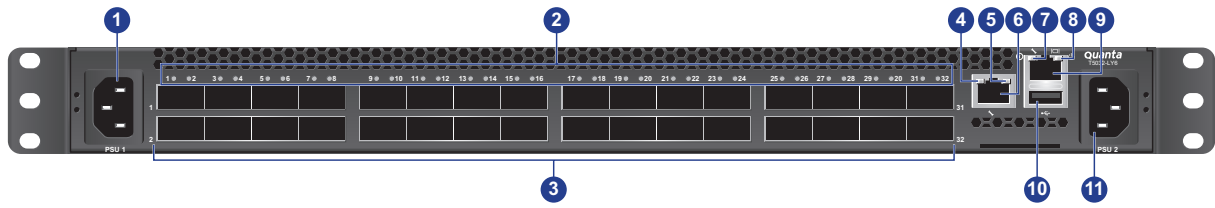

No.	Item
1	AC Power Connector (PSU1)
2	QSFP+ Port LEDs
3	QSFP+ Ports
4	Speed LED
5	Link/Activity LED
6	Management Port

No.	Item
7	System info. LED
8	Power LED
9	Console Port
10	USB Port
11	AC Power Connector (PSU2)

Rear panel

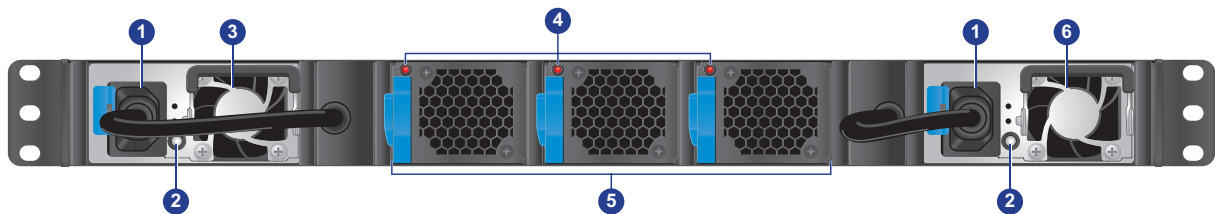

No.	Item
1	AC Power Connector (with Plug Retainer and Power Cord)
2	PSU LED
3	PSU2

No.	Item
4	Fan LEDs
5	Hot-swappable Fan
6	PSU1

Ports of T5032-LY6

The switch chassis is equipped with the following ports:

- 32 QSFP+ ports (40-Gigabit Ethernet uplink ports)
- 1 Management ports
- 1 Console port
- 1 USB port

The chassis has 32 QSFP+ ports. Each of these ports uses an optical transceiver, active optical cables, or direct-attached cable to connect the QSFP+ port to the hosts (uplink connections). For more information on obtaining the appropriate QSFP+ modules, refer to [“Supported Cables and Transceivers” on page 20](#).

One management port enables you to manage the switch operation using an RJ-45 Ethernet cable.

One console port enables you to perform the initial configuration by connecting to a PC with the RJ-45 to DB-9 serial adapter cable.

*One USB port enables you to load the configuration files from a USB storage device to the switch’s flash memory.

 **NOTE:**

- *The USB port function will be supported in the future release.

Data Port Connection

Supported Cables and Transceivers

See the following table for the list of supported cables and transceivers.

Supported Distance	Description	Note
1m	40G Direct Attach Copper (DAC) cable	QSFP+ to QSFP+
	40G DAC Fan Out cable	QSFP+ to 4 SFP+
3m	40G Direct Attach Copper (DAC) cable	QSFP+ to QSFP+
	40G DAC Fan Out cable	QSFP+ to 4 SFP+
5m	40G Direct Attach Copper (DAC) cable	QSFP+ to QSFP+
	40G DAC Fan Out cable	QSFP+ to 4 SFP+
7m	40G Active Optical Cable (AOC)	QSFP+ to QSFP+, 850 nm, MMF
10m	40G Active Optical Cable (AOC)	QSFP+ to QSFP+, 850 nm, MMF
20m	40G Active Optical Cable (AOC)	QSFP+ to QSFP+, 850 nm, MMF
> 20m	40GBASE-SR4 QSFP+ Transceiver Optic (MPO)	QSFP+, 850nm, MMF
Up to 10km	40GBASE-LR4 QSFP+ Transceiver Optic (LC)	QSFP+, SMF

 **NOTE:**

- For more information about the cable/transceiver, please contact QCT sales.

QSFP+ Port Connection (MPO Type Connector)

The switch is equipped with 32 QSFP+ (Quad SFP) ports which support 40G/per port or fan out to 4x10G by using the fan out DAC cable described in the “Supported Cables and Transceivers” on page 20.

The QSFP+ ports are numbered and have corresponding QSFP+ port LEDs.

To install a QSFP+ module, do the following:

- 1 Slide the QSFP+ module into a QSFP+ port.
- 2 Push completely until the module locks into place.

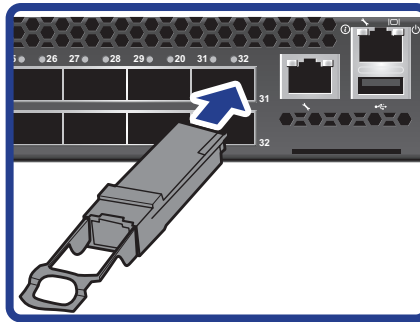

- 3 Repeat the above procedures to install additional QSFP+ modules.

The QSFP+ port LED lights green when the network link is established.

Fan Tray of T5032-LY6

The switch chassis is equipped with three fan trays. There are two types of hot-swappable fan modules. Each fan module handle is color-coded to indicate its airflow direction.

- Red: indicates front-to-back airflow.

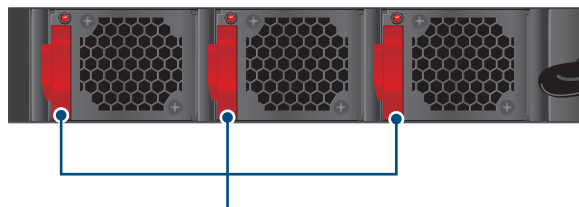

Fan module handles

- Blue: indicates back-to-front airflow.

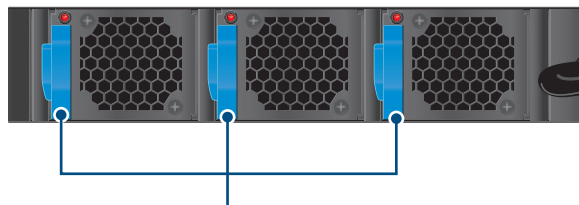

Fan module handles



NOTE:

- To hot-swap the fan during operations, make sure to replace it within two minutes.

Power Supply of T5032-LY6

Equipped with two supply modules, the switch can operate with either one or two power supply modules. If the switch uses two power supply modules, you can hot-swap one of the PSU during the operations.



NOTE:

- Only one PSU is required to operate a fully loaded chassis.

There are two types of PSU. Each plug retainer is color-coded to indicate its airflow direction.

- Red: indicates front-to-back airflow.
- Blue: indicates back-to-front airflow.

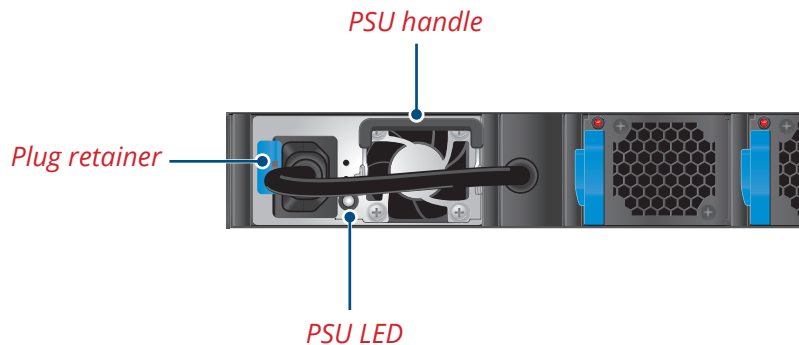

The AC power connector is a standard three-pronged connector. The switch automatically adjusts its power setting to any supply voltage in the range from 100~240 VAC at 50~60 Hz.



NOTE:

- Verify that each module has the same airflow direction. Make sure the switch runs with all of its power supply and fan tray modules taking in air from a cold aisle and exhausting air to the hot aisle.

About the AC Power Connector Connection

This switch has 2 AC power connectors on the front and rear panels. The power supply connection varies depending on the operating scenarios:

- If you are using the AC power connectors on the front panel for the power supply, make sure both power cords at the rear panel are properly connected. Then plug the power cables into the respective AC power connectors on the front panel.
- If you ONLY use the AC power connectors on the rear panel for the power supply, you have the unplug the power cords located at the rear panel first. Then plug the power cords into the respective AC power adapters, and plug the AC power adapters to a wall outlet.

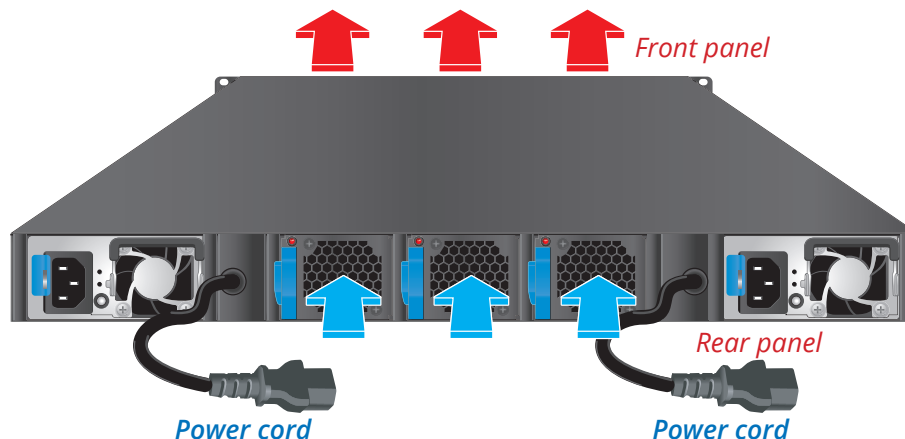

Airflow Direction

The switch ships with three fan modules and two AC power supplies. The direction of the airflow varies depending on the color of the fan module handle/plug retainer.

- Red: indicates front-to-back airflow (air inlet module).
- Blue: indicates back-to-front airflow (air outlet module).



CAUTION

- Do not mix power supplies and fan modules with different airflow in the same chassis.

Front-to-Back Airflow

The air intake is located on the front panel of the switch. The cool air is sucked in from outside the chassis and pushed toward the rear of the chassis. The hot air exhausts through the vents on the rear panel of the switch.

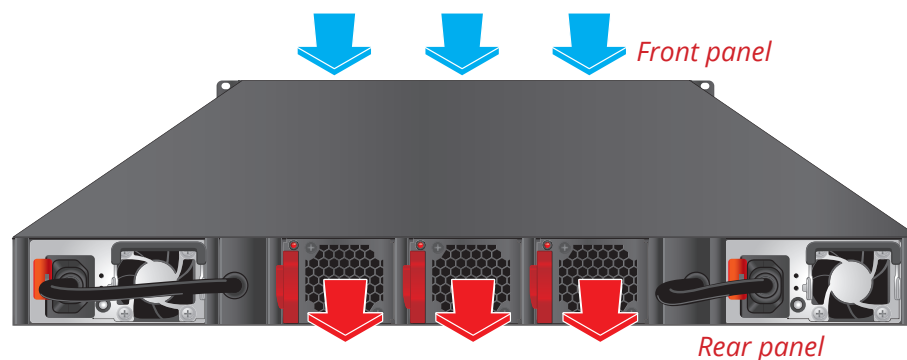

Back-to-Front Airflow

The air intake is located on the rear panel of the switch. The cool air is sucked in from outside the chassis and pushed toward the front of the chassis. The hot air exhausts through the vents on the front panel of the switch.

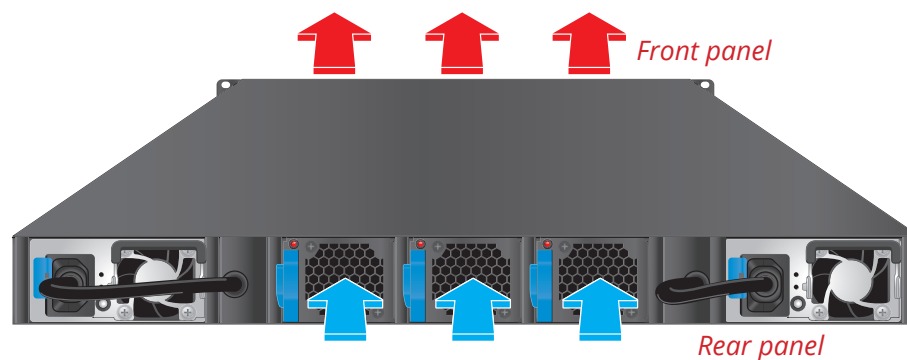

Chassis for the T3048-LY9 Switch

Front panel

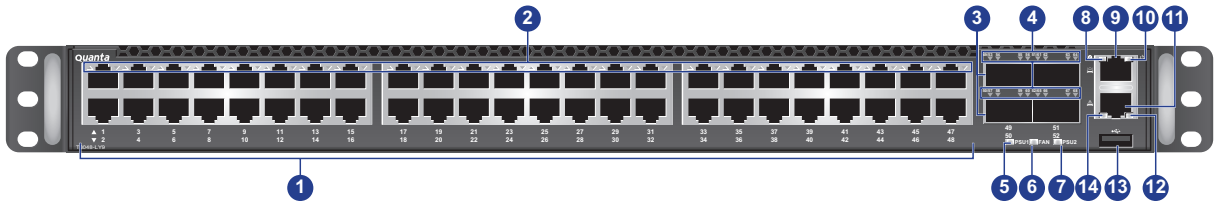

No.	Item
1	10GBASE-T Ports
2	10GBASE-T Port LEDs
3	QSFP+ Ports
4	QSFP+ Port LEDs
5	PSU1 LED
6	Fan LED
7	PSU2 LED

No.	Item
8	System info. LED
9	Console Port
10	Power LED
11	Management Port
12	Link/Activity LED
13	USB Port
14	Speed LED

Rear panel

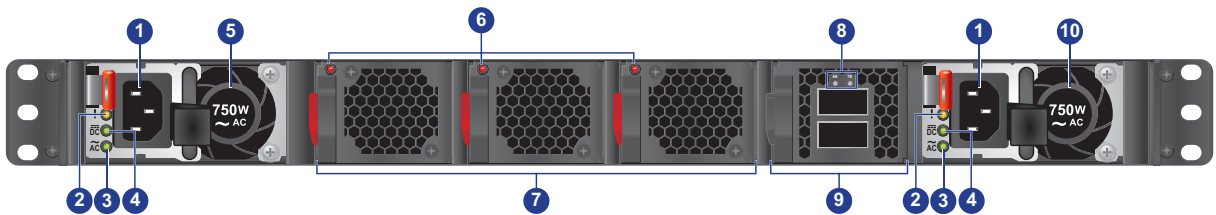

No.	Item
1	AC Power Connector (with Plug Retainer)
2	PSU Warning LED
3	PSU AC LED
4	PSU DC LED
5	PSU2

No.	Item
6	Fan LEDs
7	Hot-swappable Fan
8	QSFP+ Port LEDs
9	QSFP+ Ports
10	PSU1

Ports of T3048-LY9

The switch chassis is equipped with the following ports:

- 48 10GBASE-T ports
- 6 QSFP+ ports (40-Gigabit Ethernet uplink ports)
- 1 Management ports
- 1 Console port
- 1 USB port

The QuantaMesh T3048-LY9 is a new generation 10GBASE-T solution for data center networking which provides 48 triple speed (100/1000/10 GBase-T) ports and 6 QSFP+ ports in a 1U form factor. The 40G QSFP+ port can be independently configured as 40GbE or 4 x 10GbE. For more information on obtaining the appropriate 10GBASE-T cables and QSFP+ modules, refer to [“Supported Cables and Transceivers” on page 25](#).

One management port enables you to manage the switch operation using an RJ-45 Ethernet cable.

One console port enables you to perform the initial configuration by connecting to a PC with the RJ-45 to DB-9 serial adapter cable.

*One USB port enables you to load the configuration files from a USB storage device to the switch’s flash memory.

 **NOTE:**

- *The USB port function will be supported in the future release.

Data Port Connection

Supported Cables and Transceivers

See the following table for the list of supported cables and transceivers.

- **10GBASE-T ports**

Cable Type	1000BASE-T	10GBASE-T
Cat 5e	100m (330 ft)	Not Supported
Cat 6A	100m (330 ft)	100m (330 ft)

- **40-Gigabit ports**

Supported Distance	Description	Note
1m	40G Direct Attach Copper (DAC) cable	QSFP+ to QSFP+
	40G DAC Fan Out cable	QSFP+ to 4 SFP+
3m	40G Direct Attach Copper (DAC) cable	QSFP+ to QSFP+
	40G DAC Fan Out cable	QSFP+ to 4 SFP+
5m	40G Direct Attach Copper (DAC) cable	QSFP+ to QSFP+
	40G DAC Fan Out cable	QSFP+ to 4 SFP+
7m	40G Active Optical Cable (AOC)	QSFP+ to QSFP+, 850 nm, MMF
10m	40G Active Optical Cable (AOC)	QSFP+ to QSFP+, 850 nm, MMF
20m	40G Active Optical Cable (AOC)	QSFP+ to QSFP+, 850 nm, MMF
> 20m	40GBASE-SR4 QSFP+ Transceiver Optic (MPO)	QSFP+, 850nm, MMF
Up to 10km	40GBASE-LR4 QSFP+ Transceiver Optic (LC)	QSFP+, SMF

 **NOTE:**

- For more information about the cable/transceiver, please contact QCT sales.

Base-T Port Connection

The switch is a new generation 10GBASE-T solution for data center networking which provides 48 triple speed (100/1000/10 GBase-T) ports.

The Base-T ports are numbered and have corresponding Base-T port LEDs.

To connect to the Base-T port, do the following:

- 1 Connect one end of an Ethernet cable to the Base-T port.

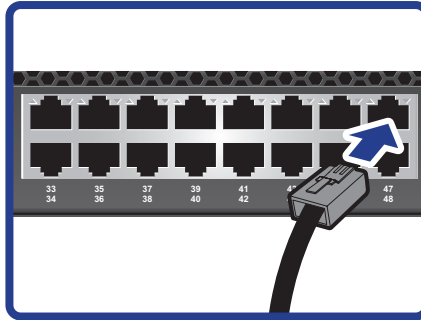

- 2 Connect the other end of the Ethernet cable to a network.

The Base-T port LED (Link/Activity LED) lights green when the network link is established.

QSFP+ Port Connection (MPO Type Connector)

The switch is equipped with 6 QSFP+ (Quad SFP) ports. There are two types of QSFP+ ports:

- There are four 40G QSFP+ ports on the front panel which support 40G/per port or fan out to 4x10G by using the fan out DAC cable described in the “40-Gigabit ports” section on [page 25](#).
- The QSFP+ port on the rear panel provides only one channel of data in one pluggable interface.

The QSFP+ ports are numbered and have corresponding QSFP+ port LEDs.

To install a QSFP+ module, do the following:

- 1 Slide the QSFP+ module into a QSFP+ port.
- 2 Push completely until the module locks into place.

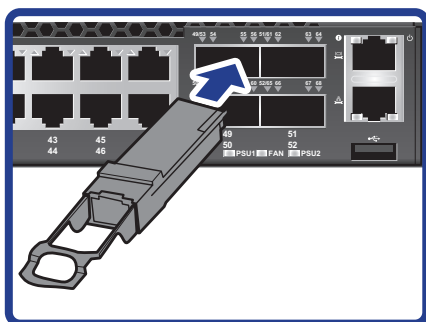

Front panel

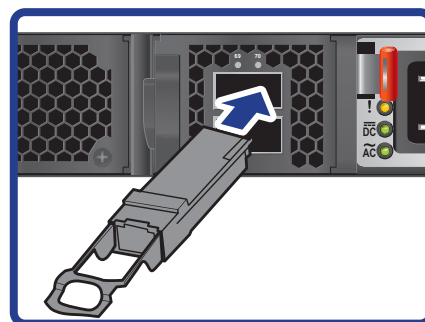

Rear panel

- 3 Repeat the above procedures to install additional QSFP+ modules.

The QSFP+ port LED lights green when the network link is established.

Fan Tray of T3048-LY9

The switch chassis is equipped with three fan trays. There are two types of hot-swappable fan modules. Each fan module handle is color-coded to indicate its airflow direction.

- Red: indicates front-to-back airflow.

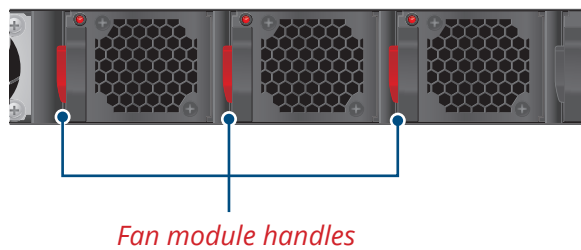

- Blue: indicates back-to-front airflow.

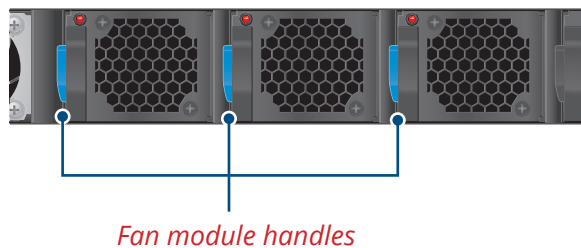

NOTE:

- To hot-swap the fan during operations, make sure to replace it within two minutes.

Power Supply of T3048-LY9

Equipped with two supply modules, the switch can operate with either one or two power supply modules. If the switch uses two power supply modules, you can hot-swap one of the PSU during the operations.



NOTE:

- Only one PSU is required to operate a fully loaded chassis.

There are two types of PSU. Each plug retainer is color-coded to indicate its airflow direction.

- Red: indicates front-to-back airflow.
- Blue: indicates back-to-front airflow.

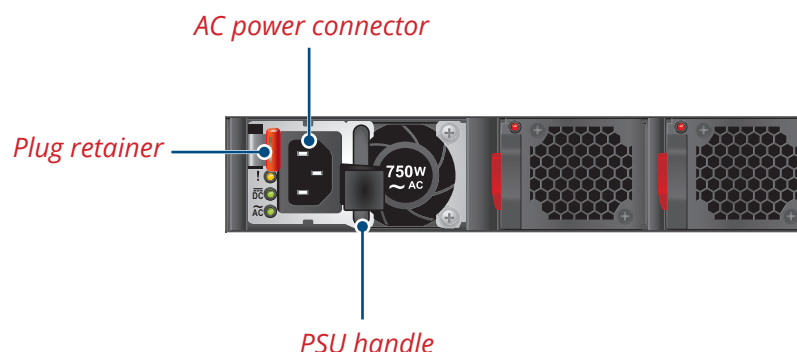

The AC power connector is a standard three-pronged connector. The switch automatically adjusts its power setting to any supply voltage in the range from 100~240 VAC at 50~60 Hz.



NOTE:

- Verify that each module has the same airflow direction. Make sure the switch runs with all of its power supply and fan tray modules taking in air from a cold aisle and exhausting air to the hot aisle.

Understanding the PSU LED

LED Type	LED Color	Function
Warning	Amber	PSU power / Thermal / Fan is not functioning properly.
AC	Green	The AC power (AC IN 220 / 110V) is operating normally.
	Off	The AC power (AC IN 220 / 110V) has failed.
DC	Green	The DC power (DC OUT +12V) is operating normally.
	Off	The DC power (DC OUT +12V) has failed.

Airflow Direction

The switch ships with three fan modules and two AC power supplies. The direction of the airflow varies depending on the color of the fan module handle/plug retainer.

- Red: indicates front-to-back airflow (air inlet module).
- Blue: indicates back-to-front airflow (air outlet module).

CAUTION

- Do not mix power supplies and fan modules with different airflow in the same chassis.

Front-to-Back Airflow

The air intake is located on the front panel of the switch. The cool air is sucked in from outside the chassis and pushed toward the rear of the chassis. The hot air exhausts through the vents on the rear panel of the switch.

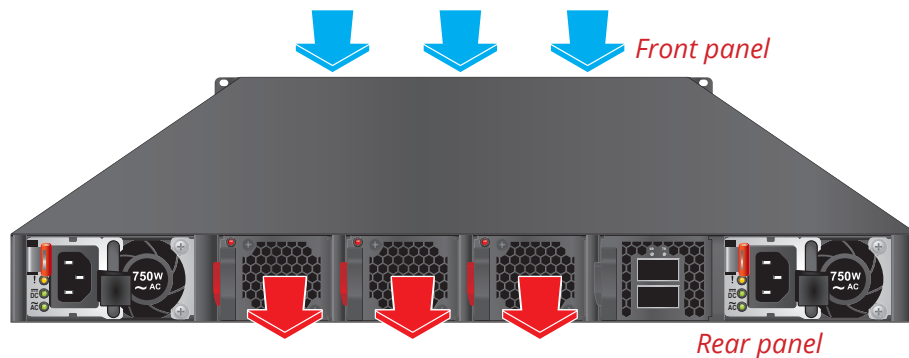

Back-to-Front Airflow

The air intake is located on the rear panel of the switch. The cool air is sucked in from outside the chassis and pushed toward the front of the chassis. The hot air exhausts through the vents on the front panel of the switch.

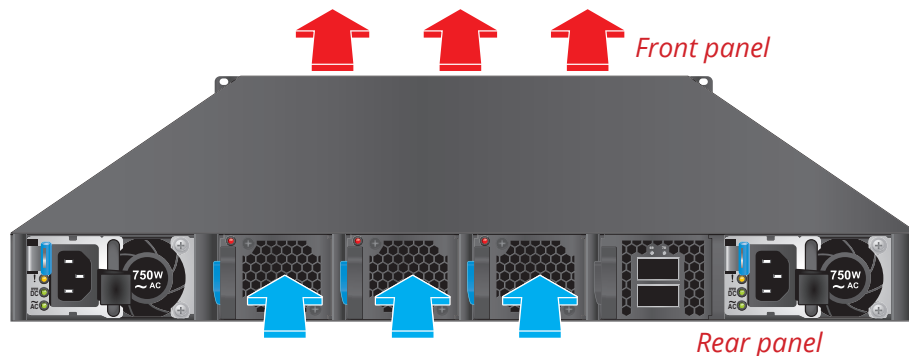

LED Descriptions

The below table describes the chassis and port LEDs for the QuantaMesh Series switches.

Chassis Indicators

System LED	Component					
	Power	System Info	OOB	PSU1/2	FAN	FAN1, 2, or 3
Green	Powering On	Booting OK	100M (left LED)	Powering On	All Fans Working Good	-
Amber	-	Booting On Going	1G (left LED)	-	-	-
Red	-	-	-	Powering Failed	Some Fans Failed	Fan Failed
Dark	Powering Off	Booting Failed	10M (left LED)	-	-	-
<i>Blinking</i>	-	-	Activity (right LED)	-	-	-

Port Indicators

Port Speed	Port Type		
	RJ-45	SFP+	QSFP+
100M	Amber On	-	-
1G	Amber On	Green On	Green On
10G	Green On	Green On	Green On
40G	-	-	Blue On
40G (rear panel)	-	-	Green On
Activity	-	<i>Blinking</i>	<i>Blinking</i>



NOTE:

- The LED lights up to indicate a valid link has been established between the port.
- The LED blinks to indicate the port is transmitting or receiving data.

HARDWARE INSTALLATION

Unpacking the Hardware

Upon receiving the switch, inspect the packing box. If the packing box was not damaged in transit, unpack it carefully.



NOTE:

- Retain the packing box in case you need to transport the switch.
- The packing box is heavy. It is recommended for two persons to carry the box and perform the installation.
- The examples used throughout this manual are based on the T3048-LY8 switch (unless specified otherwise).

Package Contents

The following items are included with a standard package. When you open the box, check if all items are included and free of damage.

- One QuantaMesh Ethernet switch
- Two AC power cords
- Console cable
- Statement paper

It is important to ensure all items are included in the package before starting the installation.

- 1 Place the box on a flat and stable surface and cut the straps securing the box.
- 2 Carefully remove the switch. Then place it on a flat and clean surface.
- 3 Remove all other items from the box and inspect each item.

Installing the Switch

Site Survey

Consider the following when choosing a location to install the switch:

Installation Location

- Ensure that there is adequate space to allow you to access the front and rear panel ports for easy cable management and maintenance.
- Ensure that the site is located within a proper distance to the power source. The power source must be properly grounded and readily accessible.
- Ensure that the site is free from strong electromagnetic field sources, such as radiators, motors, and heat sources.
- Ensure that the site is not exposed to direct sunlight, rain or moisture.

Ventilation

- The installation surroundings must have adequate ventilation. Proper clearance between the switch and the wall or other equipment must be observed.

Rack Mounting

- If installing on a rack, verify the following:
 - ✓ Ensure the cabinet is stable and secure to withstand any unexpected movement, such as an earthquake.
 - ✓ Ensure the rack or cabinet can support the weight of the switch and other additional weight.

Positioning the Switch

The switch is equipped with Power Supply Units (PSU) and hot-swappable fan modules. It is important to determine the airflow direction of the power supply and fan modules before installing the switch.

Each fan module handle/plug retainer is color-coded to indicate its airflow direction.

- Red: indicates front-to-back airflow (air inlet module). See “[Front-to-Back Airflow](#)” on page 18.
- Blue: indicates back-to-front airflow (air outlet module). See “[Back-to-Front Airflow](#)” on page 18.

To ensure proper airflow, make sure that when you install the switch its air intake is positioned in a cold aisle and the air exhaust is positioned in a hot aisle for your data center.



NOTE:

- *Verify that each module has the same airflow direction. Make sure the switch runs with all of its power supply and fan tray modules taking in air from a cold aisle and exhausting air to the hot aisle.*

Rack Mounting the Switch

You can install the switch in most standard 19-inch (48.3-cm) racks.



CAUTION

- Due to the switch's weight, it should be installed by at least two people.

Items Required for Installation

The following items are required to install the switch onto the rack:

- ✓ Phillips screwdriver
- ✓ Screws that fit the equipment rack

Installing the Switch onto the Rack

The switch can be installed directly onto the rack without the use of the rail.

- 1 Align the built-in mounting ear to the rack holes.
- 2 Tighten the screws to secure the switch.

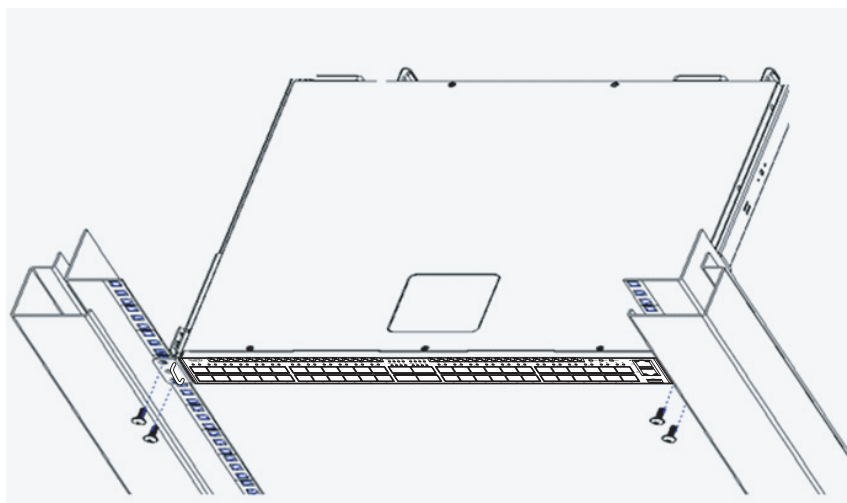

Assembling the Rails onto the Equipment Rack

1 Align the rail holes with the holes on the switch.



2 Secure them with two screws.

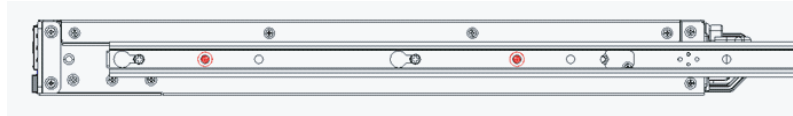

3 Pull out the internal rail.

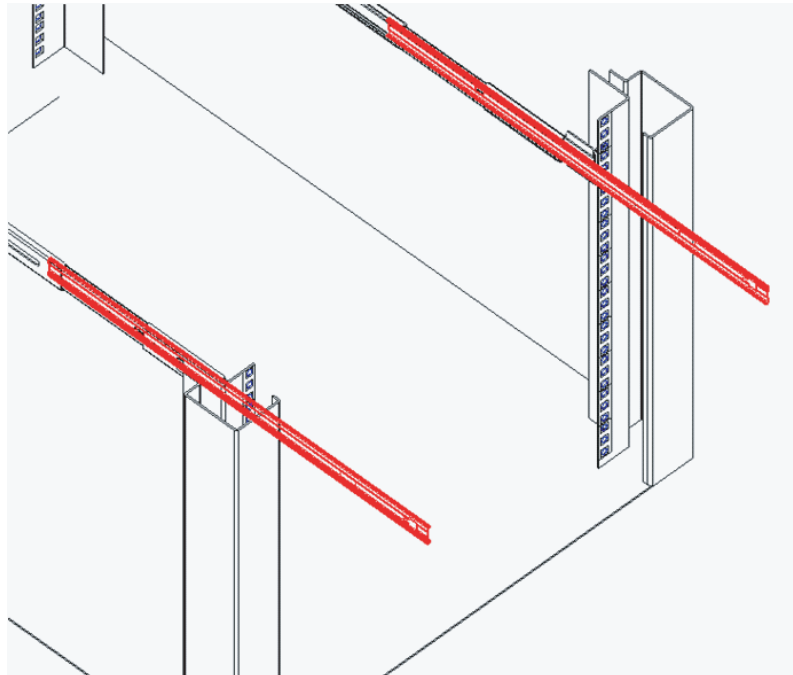

4 Align the brackets to the rail holes and secure them with screws.

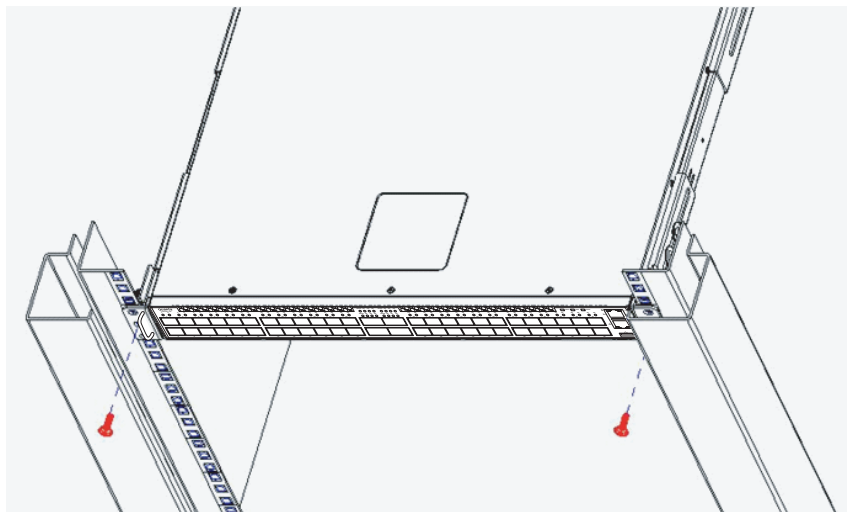

Connecting to the Console Port

The console port is used for setting up and managing the switch via a connection to a console terminal or PC using a terminal emulation program. You can connect the switch to a terminal or PC using the supplied console cable (RJ-45 male to RS-232 female cable) for serial communication.

Below is the console cable wiring specification table:

RJ-45 Port of Switch	DB9 Female Port of PC	Abbreviation	Description
3	2	RD	Received Data
6	3	TD	Transmit Data
1	8	CTS	Clear To Send
8	7	RTS	Request To Send
5	5	GND	Ground

Using the console port, you can perform the following:

- Configure the switch using the CLI commands
- Manage and monitor network activity by Command Line Interface (CLI) management
- Manage and monitor network activity by Simple Network Management Protocol (SNMP) management
- Upgrade the firmware

To connect to the console, do the following:

- 1 Connect the RJ-45 connector to the console port (🖨️) of the switch.

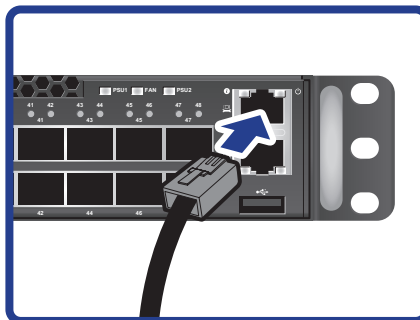

- 2 Connect the RS-232 end to a terminal or PC.
- 3 Manage the switch using the CLI commands (refer to the CLI User Manual for more information).

The switch uses the following default settings:

- Baud rate: 115200
- Data width: 8 bits
- Parity: None
- Stop bits: 1
- Flow control: None

Connecting to the Management Port

The management port is a dedicated port interface which is segregated from data traffic crossing other downlink or uplink ports. The port supports auto-negotiation. If the attached device also supports auto-negotiation, the transmission can operate in either half or full duplex, and data rate can be in 10Mbps, 100Mbps, or 1Gbps. Telnet, SNMP, and Web browser utility can all go through this port for local or remote management after the IP address, subnet mask, and default gateway are properly configured.



CAUTION

- To avoid an IP address conflict, make sure to complete the initial configuration (see “Connecting to the Console Port” on page 33) before connecting the management port to the network. For more information on how to configure the switch, refer to the CLI User Manual.

To connect to the management port, do the following:

- 1 Connect one end of an Ethernet cable to the management port () of the switch.

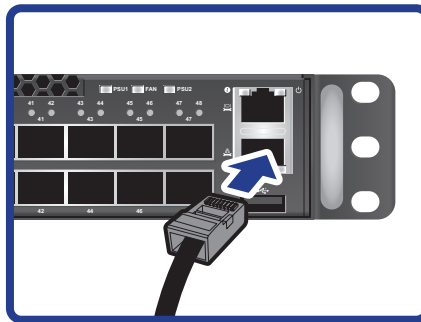

- 2 Connect the other end of the Ethernet cable to a network.

The Management port LED (Link/Activity LED) lights green when the network link is established.

Connecting the Power



CAUTION

- Ensure that the socket outlet is installed near the equipment and be easily accessible.
- The power cord must have safety ground pin or contact that is suitable for the electrical outlet.
- The power supply cord(s) must be plugged into socket outlet(s) that is/are provided with a suitable earth ground.

AC Power Supply

The switch is equipped with two slots for power supplies. Depending on your needs, you may opt to use one or both PSUs at a time. Two circuits provide redundancy protection.



NOTE:

- Each PSU has an AC power connector.
- At least one power supply must connect to a power source.

To connect the switch to a power source, do the following:

- 1 Connect one end of the AC power cord to an AC power connector.

AC power connector

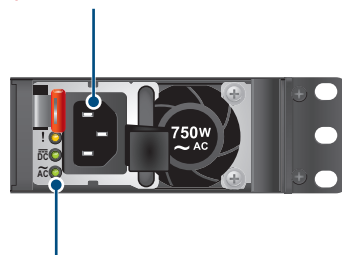

Power LED

- 2 If you want to use two PSUs, connect another strip of AC power cord to the other AC power connector. Otherwise, skip this step.
- 3 Connect the other end(s) of the AC power cord(s) to grounded power outlet(s).

The switch has no power button. Once an AC power cord is connected to a power outlet, the switch power is turned on. The Power LED lights green.



NOTE:

- T5032-LY6 switch is equipped with 2 AC power connectors on the front and rear panels. To connect the switch to a power source, refer to *“About the AC Power Connector Connection”* on page 22.

COMPONENTS REPLACEMENT

Troubleshooting

Below is a list of the common problems that you may encounter when using the switch. Try to solve these problems with the suggested solutions before calling for service. If problems persist, contact customer support.

Diagnostic Switch Indicator

Problem	Solution
Power LED is off.	The switch does not receive any power. <ul style="list-style-type: none">• Check if the AC power cords are connected properly.• Check if the power supply units are completely seated in the chassis.• The power supply unit may be damaged and needs replacement.
A Port LED is off.	<ul style="list-style-type: none">• Check if the switch and the connected device are powered on.• Check if the connection in both ends are properly connected.• Check if the cable matches the required length and specification.• Check for a defective cable/port module.
PSU 1 & PSU 2 LED is in Red state.	Possible issues: <ul style="list-style-type: none">• Fan Lock (15 sec.)• OTP: Over Temperature Process• OCP: Over Current Process• OVP: Over Voltage Process• UVP: Under Voltage Process
Fan LED is in Red state.	One or more fans have failed.

Power and Cooling Problems

If the power indicator does not turn on when the power cord is plugged in, you may have a problem with the power outlet, power cord, or power supply. However, if the unit powers off after running for a while, check for loose power connections, power losses or surges at the power outlet, and verify that the fans on the unit are unobstructed and running prior to shutdown. If you still cannot isolate the problem, then the internal power supply may be defective.

Installation

Verify that all system components have been properly installed. If one or more components appear to be malfunctioning (such as the power cord or network cabling), test them in an alternate environment where you are sure that all the other components are functioning properly.

In-Band Access

You can access the management agent in the switch from anywhere within the attached network using Telnet, a Web browser, or other network management software tools. However, you must first configure the switch with a valid IP address, subnet mask, and default gateway. If you have trouble establishing a link to the management agent, check to see if you have a valid network connection. Then verify that you entered the correct IP address. Also, be sure the port through which you are connecting to the switch has not been disabled. If it has not been disabled, then check the network cabling that runs between your remote location and the switch.

Replacing the Power Supply

CAUTION

- When installing a new PSU, make sure it has the same airflow direction as the fan modules and the other power supply.
- For switches that only using a single power supply, removing the power supply will cause the switch to automatically shutdown.

The PSUs can be replaced without the use of special tools. Before replacing any of the PSUs, verify the status of the PSU to determine if there is a need for replacement.

NOTE:

- *In the event of a power supply failure, you can replace the defective unit without powering down the system, provided that there is at least one power supply must connect to a power source.*

To replace the power supply unit, do the following:

T3048-LY8 Switch

- 1 Disconnect the AC power cord of the PSU that you want to remove.
- 2 Press the plug retainer and then pull the handle to slide the PSU away from the chassis.

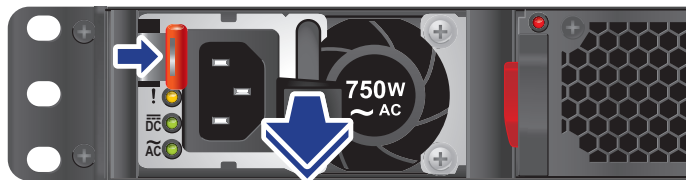

NOTE:

- *Take note of the part number of the removed PSU.*
 - *When making order for replacement modules, make sure that the part number of the new PSU is the same as the part number of the removed PSU.*
- 3 Ensure the power supply unit is correctly oriented, then install the new PSU into the chassis until it is firmly seated.
 - 4 Connect the AC power cord to power on the switch.

COMPONENTS REPLACEMENT

T5032-LY6 Switch

- 1 Disconnect the AC power cord of the PSU (on the rear panel) that you want to remove.

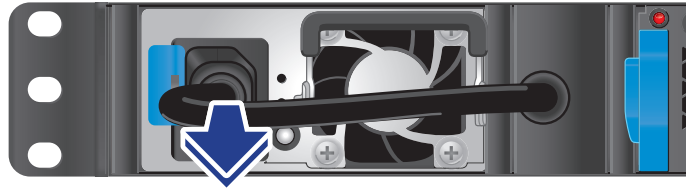

- 2 Press the plug retainer and then pull the handle to slide the PSU away from the chassis.

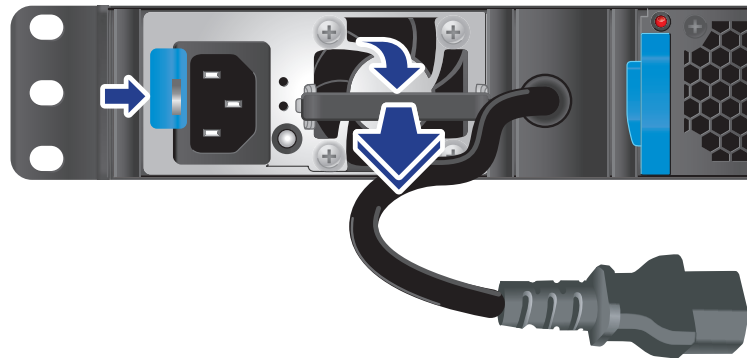

NOTE:

- Take note of the part number of the removed PSU.
 - When making order for replacement modules, make sure that the part number of the new PSU is the same as the part number of the removed PSU.
- 3 Ensure the power supply unit is correctly oriented, then install the new PSU into the chassis until it is firmly seated.
 - 4 Connect the AC power cord to power on the switch. Refer to [“About the AC Power Connector Connection”](#) on page 22.

Replacing the Fan Tray

CAUTION

- When installing a new fan module, make sure it has the same airflow direction as the fan modules and the power supply.

The fan modules can be replaced without the use of special tools. Before replacing any of the fan modules, verify the status of the fan modules to determine if there is a need for replacement.

NOTE:

- In the event of a fan failure, make sure to replace it within two minutes.

To replace the fan module, do the following:

- 1 Press the handle retainer and pull by the handle to slide the fan module away from the chassis.



NOTE:

- Take note of the part number of the removed fan module.
 - When making order for replacement modules, make sure that the part number of the new fan module is the same as the part number of the removed fan module.
- 2 Ensure the fan module is correctly oriented, then install the new fan module into the chassis until it is firmly seated.

Customer Support

WARNING

There are no user-serviceable parts inside the PSU or hot-swappable fan module.

Do not disassemble any part of the PSU or hot-swappable fan module. Doing so voids the warranty and regulatory certifications.

For maintenance services not mentioned in this guide, please contact the manufacturer's customer support number as indicated on the warranty card.

APPENDIX

The following pages in the appendix are showing the IP address configuration and firmware upgrade SOP of Quanta runtime image.

Initial Configuration Process

When using the switch for the first time, configuration must be carried out through a console. Perform the following steps to configure the switch:

- 1 Connect a terminal to the console port.
- 2 Manually configure the IP Address by CLI.
- 3 Manage the switch.

Configure the IP Address

You can configure the switch with a static IP address or use a Dynamic Host Configuration Protocol (DHCP) server to automatically obtain an IP address for the switch. For the first time configuration, it is recommended to set the IP address manually.

Set IP Address Manually

To set the IP address of the switch manually, perform the following:

- 1 Connect the switch to a computer with a terminal emulation program via the Console port.
- 2 On the terminal emulation program, select the appropriate serial port and set the following configurations:
 - Baud rate: 115200
 - Data width: 8 bits
 - Parity: None
 - Stop bits: 1
 - Flow control: None
- 3 After setting up the terminal, plug the power cable(s) to the AC power connector(s) of the switch. The boot up screen appears in the terminal. The boot up process may take a few minutes to complete.

```
Loading Application Code .....done
linux_kernel_bde: module license 'Proprietary' taints kernel.
Disabling lock debugging due to kernel taint
ls: *.so: No such file or directory
PCI unit 0: Dev 0xb538, Rev 0x11, Chip BCM56538_B0, Driver BCM56634_B0
SOC unit 0 attached to PCI device BCM56538_B0

Application starting... started!
(Unit 1)>
Applying configuration, please wait ...
Applying Global configuration, please wait ...
Applying Interface configuration, please wait ...
User:admin
```

- 4 When prompted for the User and Password, input "**admin**" for user and leave the password empty, then press <Enter>.
- 5 On the prompt, input "**configure**". The prompt changes to "**(Quanta) (Config) #**".

- 6 Set the service port IP address (in the example below, the service port IP address is set to 192.168.2.1)

Configure

Serviceport protocol none

Serviceport ip 192.168.2.1 255.255.255.0 <gateway>

exit

```
Application starting... started!
(Unit 1)>
Applying configuration, please wait ...
Applying Global configuration, please wait ...
Applying Interface configuration, please wait ...
User:admin
Password:
(Quanta) #configure

(Quanta) (Config)#serviceport protocol non

Changing protocol mode will reset ip configuration.
Are you sure you want to continue? (y/n)y

(Quanta) (Config)#serviceport ip 10.0.10.5 255.255.0.0

(Quanta) (Config)#exit

(Quanta) #
```

- 7 Input "**ip default-gateway <gateway>**" (where <gateway> is a value between 0.0.0.0 to 255.255.255.255).

- 8 From this point, the IP address, subnet mask, and gateway of the switch has been set. On the command prompt, input "**exit**" to go back one level. The prompt changes to "**(Quanta) #**".

- 9 Input "**show serviceport**" to display the network configurations of the switch.

Obtain IP Address by DHCP

By default, DHCP client is enabled. The Ethernet switch will automatically obtains the IP address, subnet mask, and default gateway from the DHCP server.

Manage the Switch

After the initial configuration, you may manage and monitor network activity by CLI or SNMP management, or by using the Web browser utility.

CLI Management

The Command Line Interface (CLI) is administered when the terminal is directly connected to the Console port of the switch. This is an out-of-band connection, which means that it is on a different circuit than normal network communications, and thus works even when the network is down. After setting the IP address of the switch, you can also use a terminal program, such as Telnet, to access and control the switch.

For more information on CLI commands, see the “CLI Documentation”.

SNMP Management

After configuring the IP address and upgrading the firmware, you can manage and monitor network activity by SNMP.

Simple Network Management Protocol (SNMP) is an application-layer protocol defined by the Internet Architecture Board (IAB) in RFC1157 for managing and monitoring network devices. SNMP is one of widely accepted protocols used to manage and monitor network elements. The switch supports SNMP version 1.0, 2.0, and 3.0.

The basic components and functions of SNMP are as follows:

- A Managed Device, in this case the switch
- An SNMP Agent
- SNMP Manager
- Management Information Database or Base (MIB)

The switch comes bundled with an SNMP Agent, which runs locally on the device. The SNMP Agent communicates with an SNMP-compatible console program, called the SNMP Manager.

The commonly shared database between the SNMP Agent and the SNMP Manager is called Management Information Base (MIB). In short, MIB files are the set of questions that the SNMP Manager can ask the SNMP Agent. The SNMP Agent collects these data locally and stores it, as defined in the MIB.

The MIBs contain a standard set of statistical and control values defined for the managed devices on a network. The SNMP protocol also allows the extension of these standard values with values specific to a particular SNMP Agent through the use of private MIBs. See the “SNMP Documentation” for more information on using SNMP.

By default, you can use the community name “public” to get SNMP objects or use “private” to get and set SNMP objects.

Telnet or SSH Management

By default, Telnet and SSH can be used to directly manage the switch without necessary settings.

Upgrade the Firmware

The switch firmware is continuously being upgraded to meet more networking demands. It is recommended to upgrade the firmware to ensure that your switch has the latest firmware for optimum performance.

Basically, the latest image file is necessary to upgrade the firmware. In some cases, the kernel version may also have to be upgraded. Check the release notes to determine if the kernel and uboot versions need to be upgraded.

Upgrade the Firmware Image File

To upgrade the image file, perform the following:

- 1 Connect the TFTP server to the switch via the management port.
- 2 Set the service port IP address using the following commands:
 - a. Connect the console cable to the console port.
 - b. On a terminal emulation program (such as Teraterm or HyperTerm), set the baud rate to 115200 (115200, n, 8, 1).
 - c. When prompted for the username and password, input “**admin**” for the username and leave the password empty.
 - d. Set the service port IP address (in the example below, the service port IP address is set to 192.168.2.1):

```
Configure
Serviceport protocol none
Serviceport ip 192.168.2.1 255.255.255.0
exit
```

```
Application starting... started!
(Unit 1)>
Applying configuration, please wait ...
Applying Global configuration, please wait ...
Applying Interface configuration, please wait ...
User:admin
Password:
(Quanta) #configure
(Quanta) (Config)#serviceport protocol non
Changing protocol mode will reset ip configuration.
Are you sure you want to continue? (y/n)y
(Quanta) (Config)#serviceport ip 192.168.2.1 255.255.25.0
(Quanta) (Config)#exit
(Quanta) #
```

- 3 Prepare the TFTP server and save the latest image file (*.img) in its root directory (assuming that the IP address is 192.168.2.100).

NOTE:

- Take note where the image is saved.

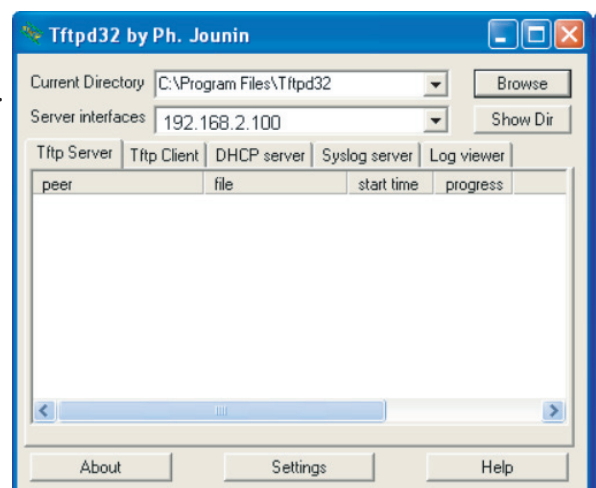

- 4 The switch supports two images. This is to ensure that if one image file fails, another backup is ready for use.
- Use the “**dir**” command to check if the image files exist.
 - If the switch already contains 2 images, you need to remove one of the images and use the “**delete <image name>**” command to delete the non-startup image.

```
(AGG1) #dir
-----
date           file name      file type startup size (byte)
-----
2013/03/13     vn-1.0.2.4.img VTracer image Y 12227432
2015/01/05     default.cfg   Config File   Y 3236
2014/12/31     ly2r-r-1.4.15.04.img Operation V 12608230
2013/11/14     ly2r-r-1.4.10.00.img Operation N 12530833
-----

Total: 4 files.

(AGG1) #delete ly2r-r-1.4.10.00.img
Are you sure you want to delete? (y/n) y
Image File "ly2r-r-1.4.10.00.img" Deleted!
```



- 5 Input the following command to update the image:
“**copy tftp://<server ip addr>/<file name> image <file name>**”.

```
(AGG1) #delete ly2r-r-1.4.10.00.img
Are you sure you want to delete? (y/n) y
Image File "ly2r-r-1.4.10.00.img" Deleted!

(AGG1) #copy tftp://192.168.2.100/ly2r-r-1.4.16.00.img image ly2r-r-1.4.16.00.img
Mode..... TFTP
Set Server IP..... 192.168.2.100
Path..... /
Filename..... ly2r-r-1.4.16.00.img
Data Type..... Code
Destination Filename..... ly2r-r-1.4.16.00.img

Management access will be blocked for the duration of the transfer
Are you sure you want to start? (y/n)
```

- 6 Input the following command to set the new image as the “next boot” image:
“**boot-system opcode <file name>**”.

```
(AGG1) #boot-system opcode ly2r-r-1.4.16.00.img

Start Up Success!
```

- 7 Reboot the switch.
- 8 After the system boots up, input “**show version**” to display and verify the updated version.

Upgrade Kernel and Rootfs

After upgrading the firmware image file, check if there is a need to upgrade the kernel and root file system.

To determine whether an upgrade is necessary, perform the following:

- 1 Boot to normal mode and execute the “**whichboot**” command to check the switch kernel version.

```
(Quanta) #whichboot
```

file name	file type	startup
lb9-kernel-1.0.5.0.img	kernel image	Y
default.cfg	Config File	Y
lb9-r-1.4.12.02.img	Operation	Y

- 2 Check the firmware release notes to determine whether an upgrade is necessary.

To upgrade the kernel and root file system, perform the following:

- 1 Connect the TFTP server to the switch via the management port.
- 2 Set the service port IP address using the following commands:
 - a. Connect the console cable to the console port.
 - b. On a terminal emulation program (such as Teraterm or HyperTerm), set the baud rate to 115200 (115200, n, 8, 1).
 - c. When prompted for the username and password, input “**admin**” for the username and leave the password empty.
 - d. Set the service port IP address (in the example below, the service port IP address is set to 192.168.2.1):

```
Configure
Serviceport protocol none
Serviceport ip 192.168.2.1 255.255.255.0
exit
```

```
Application starting... started!
(Unit 1)>
Applying configuration, please wait ...
Applying Global configuration, please wait ...
Applying Interface configuration, please wait ...
User:admin
Password:
(Quanta) #configure
(Quanta) (Config)#serviceport protocol non
Changing protocol mode will reset ip configuration.
Are you sure you want to continue? (y/n)y
(Quanta) (Config)#serviceport ip 192.168.2.1 255.255.25.0
(Quanta) (Config)#exit
(Quanta) #
```

- 3 Prepare the TFTP server and save the latest image file (*.img) in its root directory (assuming that the IP address is 192.168.2.100).



NOTE:

- Take note where the image is saved.

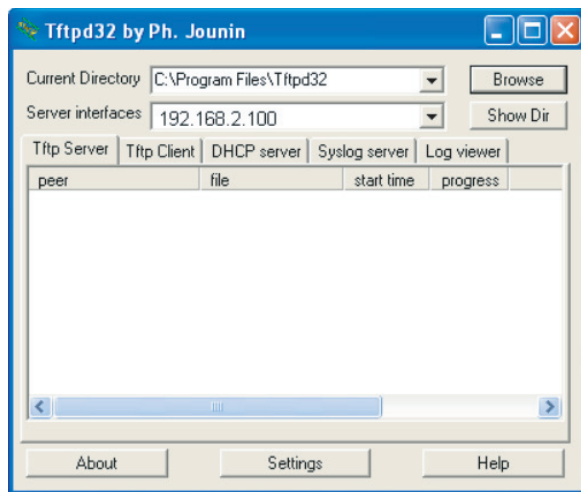

- 4 Use the following commands to download package file:
"copy tftp://<server ip addr>/<package filename> package"
- 5 Once complete, input **"reload"** to reboot the switch.

```

Package transfer operation completed successfully.
Please reboot the system.

(Quanta) #copy tftp://192.168.2.100/lb9-package-1.4.12.02.img package

Mode..... TFTP
Set Server IP..... 192.168.2.100
Path..... /
Filename..... lb9-package-1.4.12.02.img
Data Type..... package

Management access will be blocked for the duration of the transfer
This will take several minutes.

Do not power off the switch !!!
Are you sure you want to start? (y/n) y

TFTP receive complete... storing in Flash File System...

File type is kernel file ...
Saving code file ...

File type is rootfs file ...
Saving code file ...

Package transfer operation completed successfully.
Please reboot the system.

(Quanta) #reload
  
```

Manually Install Vendor OS

With QUANTA ONIE code, it allows user to manually download an installer. You can use the *Download Installer* function which supports 3 types of different protocols (i.e. FTP, TFTP, and HTTP) to download the installer file from your local server.

To download and update the vendor OS code manually, perform the following:

- 1 Locate the specific QUANTA ONIE installer image that you want to download.

For example, the installer file name: **ly3-onie-installer-1.5.3**

- 2 Place the installer file into your local FTP, TFTP, or HTTP server.

For example, the server IP address: **192.168.2.153**

- 3 Go to ONIE Linux Shell.

- a. Connect your PC and the switch using a console cable.
- b. Enter ONIE Linux Shell.

```
Hit any key to stop autoboot: 0
Loading Open Network Install Environment ...
Platform: powerpc-quantaly3-r0
Version : 1.5.3-20131014174847
WARNING: adjusting available memory to 30000000
## Booting kernel from Legacy Image at 01000000 ...
   Image Name:   quanta_ly3-r0
   Image Type:   PowerPC Linux Multi-File Image (gzip compressed)
   Data Size:    3478939 Bytes = 3.3 MiB
   Load Address: 00000000
   Entry Point:  00000000
   Contents:
     Image 0: 2761944 Bytes = 2.6 MiB
     Image 1: 707476 Bytes = 690.9 KiB
     Image 2: 9503 Bytes = 9.3 KiB
   Verifying Checksum ... OK
## Loading init Ramdisk from multi component Legacy Image at 01000000 ...
## Flattened Device Tree from multi component Image at 01000000
Booting using the fdt at 0x134f0bc
Uncompressing Multi-File Image ... OK
Loading Ramdisk to 2ff53000, end 2ffffb94 ... OK
Loading Device Tree to 03ffa000, end 03fff51e ... OK
Cannot reserve gpages without hugetlb enabled
setup_arch: bootmem
quanta_ly3_setup_arch()
arch: exit

pci 0000:00:00.0: ignoring class b20 (doesn't match header type 01)

ONIE: Using default IPv4 addr: eth0: 192.168.3.10/255.255.255.0
cat: can't open '/var/run/onie/dhcp.logsrv': No such file or directory
discover: installer mode detected. Running installer.

Please press Enter to activate this console. To check the install status inspect /var/log/onie.log.
Try this: tail -f /var/log/onie.log

** Installer Mode Enabled **
ONIE:/ # ONIE: Using default IPv4 addr: eth0: 192.168.3.10/255.255.255.0
ONIE: Starting ONIE Service Discovery

ONIE:/ #
```

- c. Use the following command to stop ONIE service discovery:

"killall discover"

```
** Installer Mode Enabled **
ONIE:/ # ONIE: Using default IPv4 addr: eth0: 192.168.3.10/255.255.255.0
ONIE: Starting ONIE Service Discovery

ONIE:/ # killall discover
ONIE:/ #
```

- d. Use the following command to set your switch box IP address:

"ifconfig eth0 192.168.2.1".

```
ONIE:/ #
ONIE:/ # ifconfig eth0 192.168.2.1
ONIE:/ #
```

- *ifconfig eth0*: the command string
- *192.168.2.1*: the switch IP address

- e. Use the “**ipconfig**” command to verify if the IP address setting is correct.

```
ONIE:/ # ifconfig
eth0      Link encap:Ethernet  HWaddr 00:C0:9F:01:02:03
          inet addr:192.168.2.1  Bcast:192.168.2.255  Mask:255.255.255.0
          UP BROADCAST RUNNING MULTICAST  MTU:1500  Metric:1
          RX packets:0 errors:0 dropped:0 overruns:0 frame:0
          TX packets:0 errors:0 dropped:0 overruns:0 carrier:0
          collisions:0 txqueuelen:1000
          RX bytes:0 (0.0 B)  TX bytes:0 (0.0 B)
          Base address:0x8000

ONIE:/ #
```

- 4 In ONIE Linux shell, use the “**install_url**” command to update the vendor OS code.

Use one of the following commands:

“install_url tftp://192.168.2.153/ly3-onie-installer-1.5.3”

or

“install_url ftp://192.168.2.153/ly3-onie-installer-1.5.3”

or

“install_url http://192.168.2.153/ly3-onie-installer-1.5.3”

- *install_url*: the command string
- *tftp/ftp/http*: use: the server protocol type
- *192.168.2.153*: the server IP address that stores the installer file
- *ly3-onie-installer-1.5.3*: the installer file